



ATENA S.P.A. HAS A QUALITY
MANAGEMENT SYSTEM
CERTIFICATED BY RINA
IN COMPLIANCE WITH ISO 9001



Metal Baffle

Mix in



ELEMENTS DIMENSION

Baffle **30** x 150 mm **MX** carrier
Custom-made panel

Maximum Baffle length 2800 mm.
Maximum panel dimensions: 400 x 2800 mm

MATERIALS

7/10 Aluminum and steel
Thickness according to the project and product requirements

STRUCTURE

MX carrier made up of 8/10 black pre-painted steel or
post-painted with color on request

ANTISEISMIC DEVICES

Atena antiseismic kit for standard plenum $\leq 1,2$ m
Atena antiseismic kit for high plenum $> 1,2$ m

HANGERS

Threaded bar
Suspensions to evaluate according to the load at m^2 , to the
project features and antiseismic requirements.

COLORS

Atena standard white and silver pre-painted steel.
Atena standard white and silver pre-painted aluminium.
RAL/NCS post-painting.

FINISHING

Plain or perforated surface.
Wood effects | Sublimation and digital printing
of images and effects

PERFORATION

Perforation to choose among Atena perforations model.

ACCESSORIES

Smooth closing caps on request, Baffle and carrier joints,
alignment clips.

SECTIONS

Baffles base 30 and smooth or perforated Mix in
panels, hook on carriers variable distance.

Baffle MX carrier



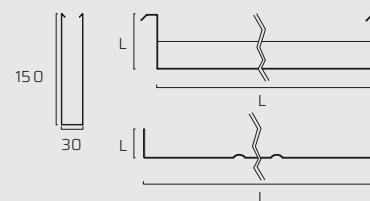



BAFFLE AND PANEL SECTIONS



TECHNICAL PERFORMANCES

	FLEXION RESISTANCE	Maximum span mm 1200 - 1 Class EN13964
	CORROSION RESISTANCE	Galvanized steel products: C2 Class Pre-painted galvanized steel products: C3 Class Post-painted galvanized steel products: C4 Class Pre/post-painted aluminium products: C5 Class
	(RH%) RELATIVE HUMIDITY RESISTANCE	Galvanized steel products: ≤ 90% Pre/post-painted galvanized steel products: > 90% Stainless steel and aluminium products: > 90%
	FIRE REACTION UNI EN 13501-1	Structure, suspensions and wall angles: A1 Class Smooth or perforated Baffle with Plus acoustic fleece: A1 Class Perforated Baffle with Standard acoustic fleece: A2s1d0 Class
	ACOUSTICS	Information in "Acoustic Performance"
	CLEANING	Wet cloth with warm water and neutral non-abrasive detergents.
	COLOR STABILITY	In compliance with technical tolerances standard. Test according to the ΔE - CIELab method. ISO 7724-2 (3)
	DURABILITY OF PAINTED ITEMS	C Class EN13964
	GALVANIZED DURABILITY	B Class EN13964

SUSTAINABILITY

	RELEASE OF DANGEROUS SUBSTANCES*	None CAM 2.4.13 EN13964		FORMALDEHYDE*	E1 Class CAM 2.3.5.5
	DISASSEMBLY*	Steel Aluminium 100% recyclable CAM 2.4.11		MATERIAL DEMOLITION AND REMOVAL*	Non hazardous waste in compliance with CAM 2.5.1.
	RECYCLED PRODUCT CONTENT*	CAM 2.4.18 compliance		GREEN BUILDING	Requirements: LEED (BREEAM and ITACA for cross-section aspects)

* Data declaration as required by the ISO 14021 standard

AXONOMETRY AND SECTION OF MX CARRIER SYSTEM

MX carrier view

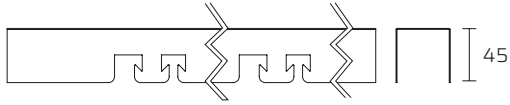

Variable pitch and escape

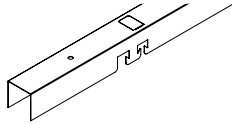

BAFFLE AND PANEL SECTIONS

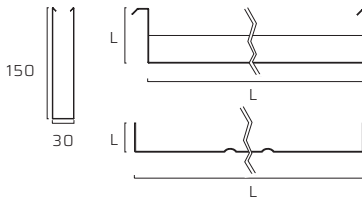

*verify **interaxes** and **hanger models** according to the load at m² the antiseismic report and particular conditions when required. The **fastening** must be checked with regard to the loads, the anchoring base features and the installation accuracy, in order not to compromise the stability of the metal ceiling system. Lightings, accessories and systems must not weigh on the metal ceiling system, but must be independently suspended.

COMPONENT INCIDENCES

ID	DESCRIPTION	INCIDENCE*
1	BAFFLE MIX IN BASE 30 H 150	-
2	MIX IN PANEL 400x1200 mm	-
3	MX CARRIER	1 pcs/sqm
4	HANGER	1 lm/sqm

HANGING MODE

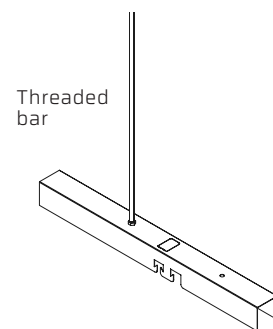

ANTISEISMIC EQUIPPMENTS

According to the NTC 2018, when the non-structural element is assembled on site: structure designer is in charge of identifying the request, the supplier and / or installer is in charge of providing elements and connection systems of adequate capacity, the project manager is in charge of verifying the accuracy of installation". Therefore it is necessary to communicate to Atena the stresses acting on the false ceiling (seismic acceleration, wind load..) in order to allow a proper calculation of the single elements. For more information on Atena's anti-seismic systems, contact the reference sales offices. The documentation on the site is for example only. (NTC 2018 § 7.2.3-7.2.4).

LOCKING SYSTEM

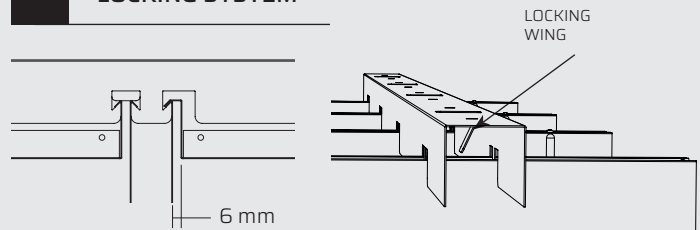

LIGHTING BAFFLE

To create a lighting false ceiling without any interruption between luminous element and Baffle body, Atena S.p.A. has developed the "Lighting Baffle"; this special element is properly shaped to lodge LED bars, with opal or microprismatic screen, for an effect of diffuse or punctual light.

LIGHTING BAFFLE
BASE 50

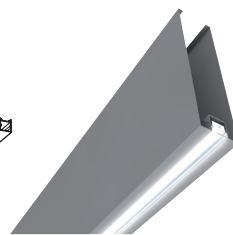
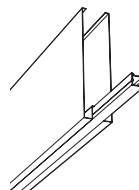

LIGHTING BAFFLE
BASE 30

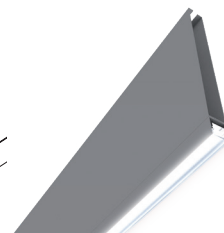
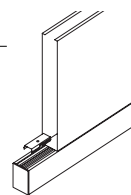

PERFORATIONS

Baffles are widely used to improve the acoustic comfort. They can be used alone or in addition to the existent false ceiling. As well as for the acoustic function Baffles help to preserve the natural lighting and the air flow coming from windows and roof. From the acoustic point of view, Baffles can be used as absorbers or deflectors of the sound wave. According to project requirements, vertical elements may be totally plain to promote sound reflection or perforated and filled with acoustic pad to absorb noises. To choose the right vertical elements to apply, the acoustic material, the number of Baffles and their disposition, it is necessary to carry out a preliminary analysis of the environment and its functions. To do this, Atena S.p.A. cooperates with specialized companies to provide a specific service for acoustic treatment.

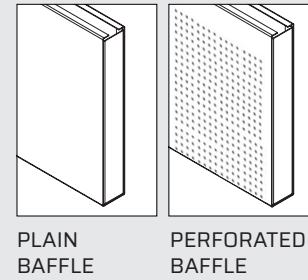

Ø = 0,75 ≤ 1,5 mm PERFORATIONS

PARALLELE

AP 0,75 / 2% P

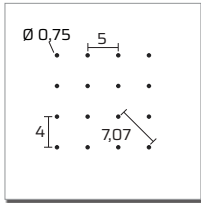

AP 1,5 / 11% P

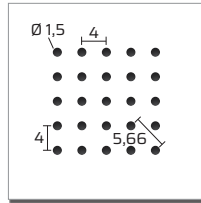

DIAGONALI

AP 1,5 / 22% D

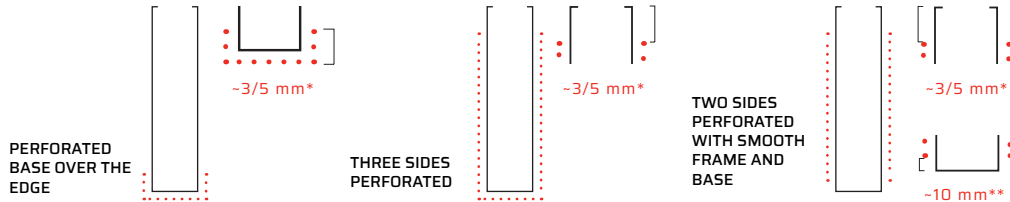
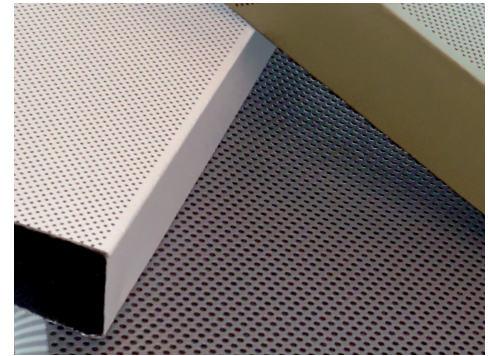
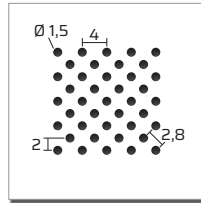

- Perforated area
- * Depending on the step of drilling
- ** Depending on the step of drilling; not applicable on base 30 mm

Ø = 1,8 ≤ 2 mm PERFORATIONS

PARALLELE

AP 1,8 / 9,5% P

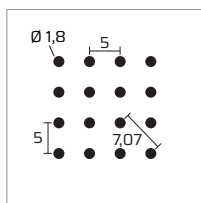

AP 2 / 12,5% P

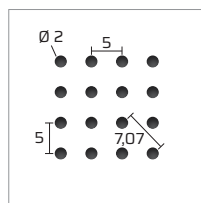

DIAGONALI

AP 1,8 / 19% D

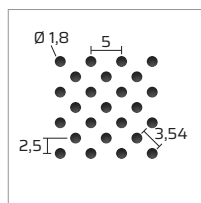

AP 2 / 25% D

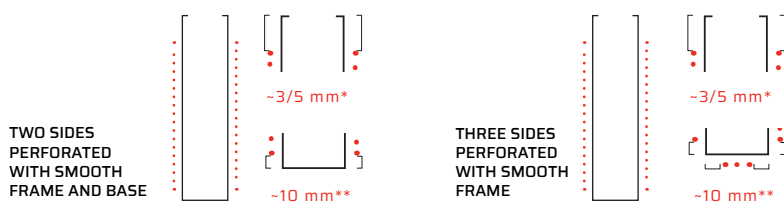
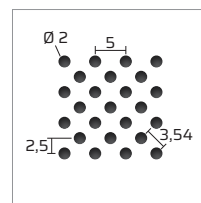

MATERIALS Drillable steel-aluminum thickness

PERFORATION	THICKNESS			CL	PW
	0,5	0,6	0,7		
AP 0,75/2% P	•	•	NA	1000	850
AP 1,5/11% P	•	•	•	1300	1300
AP 1,8/9,5% P	•	•	•	900	800
AP 2/12,5% P	•	•	•	1250	1200
AP 1,5/22% D	•	•	•	1300	1300
AP 1,8/19% D	•	•	•	900	800
AP 2/25% D	•	•	•	1250	1200

NA= Not available
CL= Maximum coil length
PW= Maximum perforation width
6/10 only for 30 H100 and 50 H100 models.

INSTALLATION STEPS

1/2 Draw the lines of the perimeter frame. Determine the height of the ceiling with a level and mark it with a string.

3 Install the hangers and hook on the carriers according to the interaxe required by the project.

4 Hook the Baffles on the MX carrier.

5 Clip the panels in the carrier by overlapping one side on the Baffle flap.

6 Install the closing cap if required.

7 Install the Baffle joints to guarantee the continuity of the elements.

8 To disassemble the system unclip the panels then unhook the Baffles.

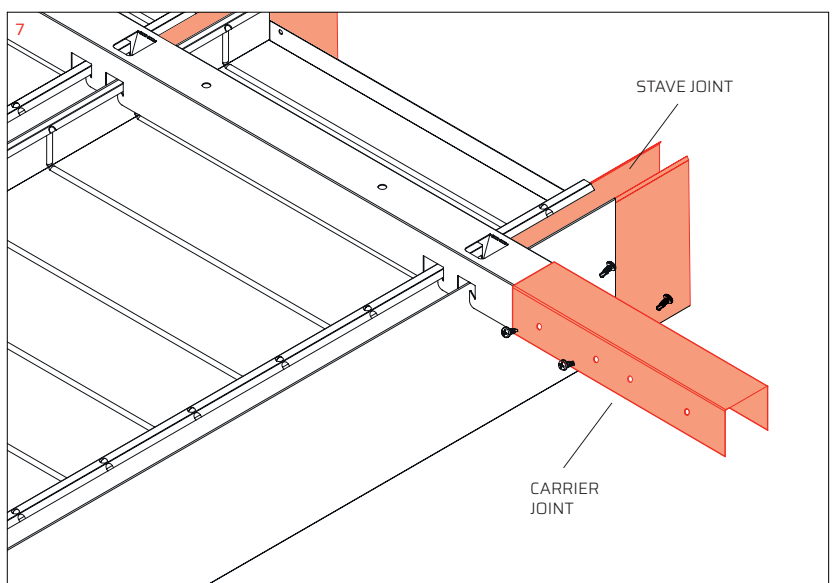
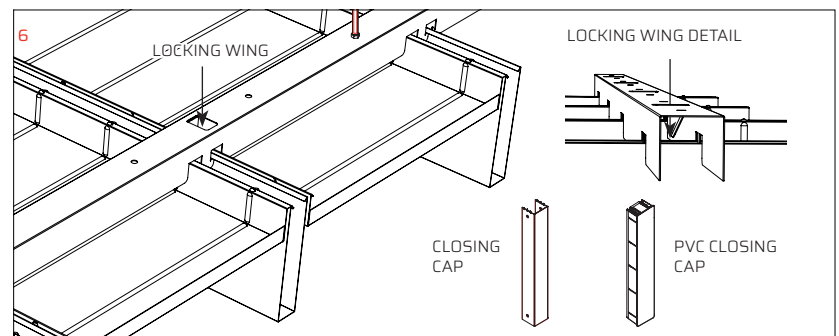
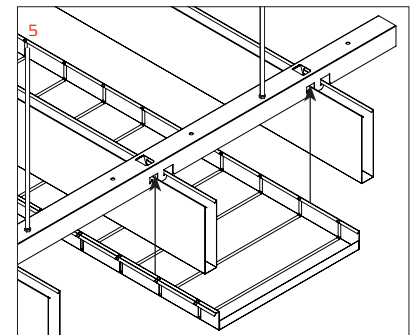
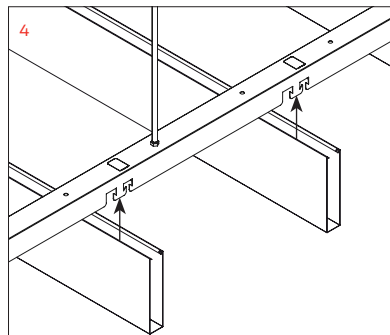
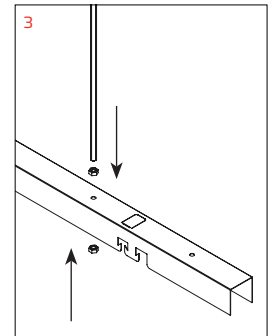
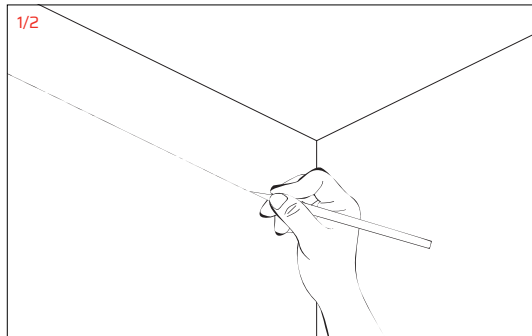

*verify **interaxes** and **hanger models** according to the load at m² the antiseismic report and particular conditions when required. The **fastening** must be checked with regard to the loads, the anchoring base features and the installation accuracy, in order not to compromise the stability of the metal ceiling system. Lightings, accessories and systems must not weigh on the metal ceiling system, but must be independently suspended.

CLEANING, MAINTENANCE AND REMOVAL INSTRUCTIONS

Cleaning and maintenance require some attention and care even though are easy to make and don't take much time. It is necessary to use warm water and neutral and non-abrasive detergents. Metal ceilings maintenance usually refers to: placement, alignment or replacement of damaged or broken modules (panels, staves, baffles, open cells) which can be also removed for restoration or maintenance of the system below.

In order to ensure an excellent results, the maintenance work must be carried out by specialised workers trained with technical data sheets about setting, removal and maintenance of the metal ceilings. Using inadequate tools can damage the bearing structure, causing adherence loss or even accidental modules fall. All the maintenance intervention must follow the technical data sheet instructions or specific information when provided and every diversity has to be promptly reported. Each worker charged with maintenance operation must carefully remove the modules, perform the intervention and do not alter the metal ceiling structure, the hanging system and the connection between these elements.

When the maintenance is over, modules must be installed again, checking that these are well hooked or positioned if they are lay-in/on a visible structure and that the flatness of the assembly is guaranteed. Any difference in level is caused by wrong installation and, for this reason, the system must be quickly controlled.

STORAGE MODE

Materials supplied by Atena S.p.A. shall be maintained in good condition from purchase to installation. Materials must be stored in a closed, clean and dry site, not under direct light. Atena S.p.A. protects its products with resistant packaging under normal handling. Please handle packages with care to avoid shocks and inappropriate handling that might damage what is provided. The manual handling must be carried out with caution and in compliance with safety regulations at work. For carriage of packaged products on pallets, provide a mechanical transport to avoid damages or risks resulting from inadequate transport.

SUSTANABILITY AND SAFETY

All Atena metal ceilings are made with products that do not release dangerous substances into the environment including formaldehyde. Coating and / or sublimation are free from Volatile Organic Compounds (VOC). The products will be recyclable and as a whole manufactured using recycling processes materials, the recycled material percentage is calculated for each type of product, in compliance with CAM requirements and declared according to the ISO 14021 standard. The metal ceiling systems contribute to getting credits for the certification of building design, construction and sustainable and efficient management according to the LEED protocol and to the BREEAM and ITACA cross-cutting aspects.

FASTENERS

Atena supplies the hangers and accessories such as screws, washers and nuts to connect the elements of its own supply only. Lightings, accessories and systems must not weigh on the metal ceiling system, but must be independently suspended. The fastening must be checked with regard to the loads, the anchoring base features and the installation accuracy, in order not to compromise the stability of the metal ceiling system.

NORMATIVE REQUIREMENTS

Atena S.p.A. has adopted a quality management system in compliance with the UNI EN ISO 9001 standard.

All Atena metal ceilings are produced for indoor applications, in compliance with Technical Standards for Construction NTC 2018 and relative circular requirements, the Minimum Environmental Criteria CAM (Ministerial Decree 11 October 2017), the specific technical standards applicable UNI EN 13964 and 14195. Each Atena S.p.A. product has its own DOP (CE Declaration of Performance) according to the European Law for construction products 305/2011.

The performance properties declared in D.o.P. Declarations of Performance provided by Atena S.p.A. are guarantees, if the metal ceiling is installed in the environment conditions for which it has been conceived and the recommended maintenance is executed.

Precisely, metal ceilings are non-structural construction elements therefore they must be properly sized in order to withstand with adequate safety against all actions that can stress the building, such as, but not limited to, earthquakes, winds, thermal expansion, humidity, etc., in relation to the installation site, the building use and the project technical features. Check with Atena technical department the specific environmental conditions to which the product will be subjected, in order to choose the most suitable materials for the installation site.

In the case of outdoor installation, the metal ceilings are not covered by an harmonized technical standard, therefore they are not subject to the regulation 305/2011. They are in any case subjected to the NTC 2018 and to the safety checks of civil constructions, and must be properly sized according to the installation site environmental conditions, to the structural features and to the project specifications.

Independently by information, suggestions, advices and technical opinions exchanged between the parts, during pre-agreement negotiations Atena S.p.A. will manufacture the products only according to the orders received and the technical drawings/projects attached, having no responsibility on what is not indicated in the order, in the technical drawings or in the project.

All rights are reserved and subject to industrial protection. Changes to the illustrated products, even if partial, can be carried out only if explicitly authorized by the company Atena S.p.A. All data provided and illustrated are indicative and Atena S.p.A. reserves the right to make changes at any time according the business needs and the production processes.

The information contained in this following sheet must to be considered updated at the date of writing. Changes in product performance occurred after that date may affect the accuracy of the data sheet: it is compulsory for users to make sure to have the latest version of this sheet.

WARRANTY

Atena S.p.A. as a manufacturer, covers the manufacturing defects of its products; Except as provided in the specific warranty extensions, the warranty period is one year from delivery of goods. Any complaints must be communicated in accordance with the sales terms and conditions.

The Atena metal celings system components have been conceived for this purpose only, any other use is considered improper.